

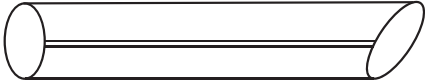









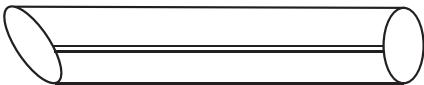
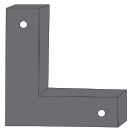
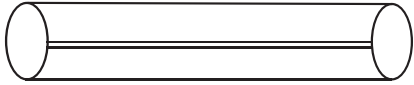
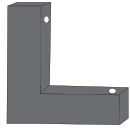
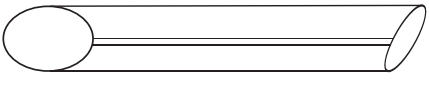
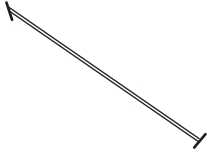
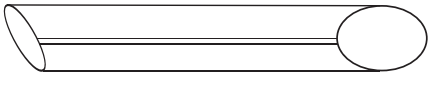
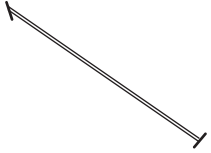
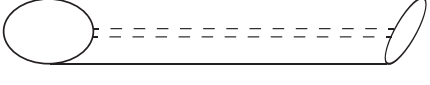
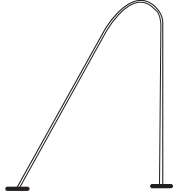
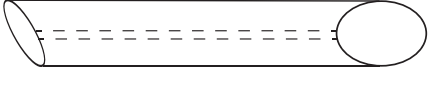

### INVENTAIRE PIECES

	<b>FG000-AL-HEL</b> x2		<b>FG1FIX-AL-SQS</b> x4
	<b>FG000-AL-HER</b> x2		<b>FG03</b> x4
	<b>1120MM-AL-HM</b> x2		<b>FG03B</b> x2
	<b>FG702-AL-SL</b> x1		<b>FG4FIX-ST-LB</b> x2
	<b>FG702-AL-SR</b> x1		<b>FG5FIX-ST-SB</b> x2
	<b>FG702-AL-PUR</b> x1		<b>FG4FIX-ST-NS</b> x2
	<b>FG702-AL-PUL</b> x1		

### INVENTAIRE OUTILLAGE

	<b>FG0BRK-ST-STR</b> x4		<b>FGB25W</b> x50		<b>FGB50V</b> x2
	<b>FG0BRK-ST-CRN</b> x4		<b>FGBN</b> x52		<b>FGBSQN</b> x8
	<b>FG0BRK-ST-AAC</b> x2		<b>FGB100H</b> x8		<b>FG02</b> clips filet

## AVERTISSEMENTS

- L'installation de ce but doit se faire sans aucun marteau ou autre outil de force. Leur utilisation endommagera les pièces et annulera toute garantie sur le but.
- Les buts sont fournis avec des autollants comprenant les déclarations de normes de sécurité. Ces autocollants doivent à tout moment être fixés sur le but et visibles. L'absence de l'affichage des normes de sécurité annule la garantie.
- En cas de difficulté ou problème avec le but, veuillez contacter le fabricant par mail avec des photos : Lynxsport GmbH - [info@lynxsport.fr](mailto:info@lynxsport.fr).

**ÉTAPE 1 : VIS**



Poser toutes les pièces au sol suivant le schéma ci-dessous.

Avant d'emboîter les tubes, glisser toutes les vis dans les gouttières.

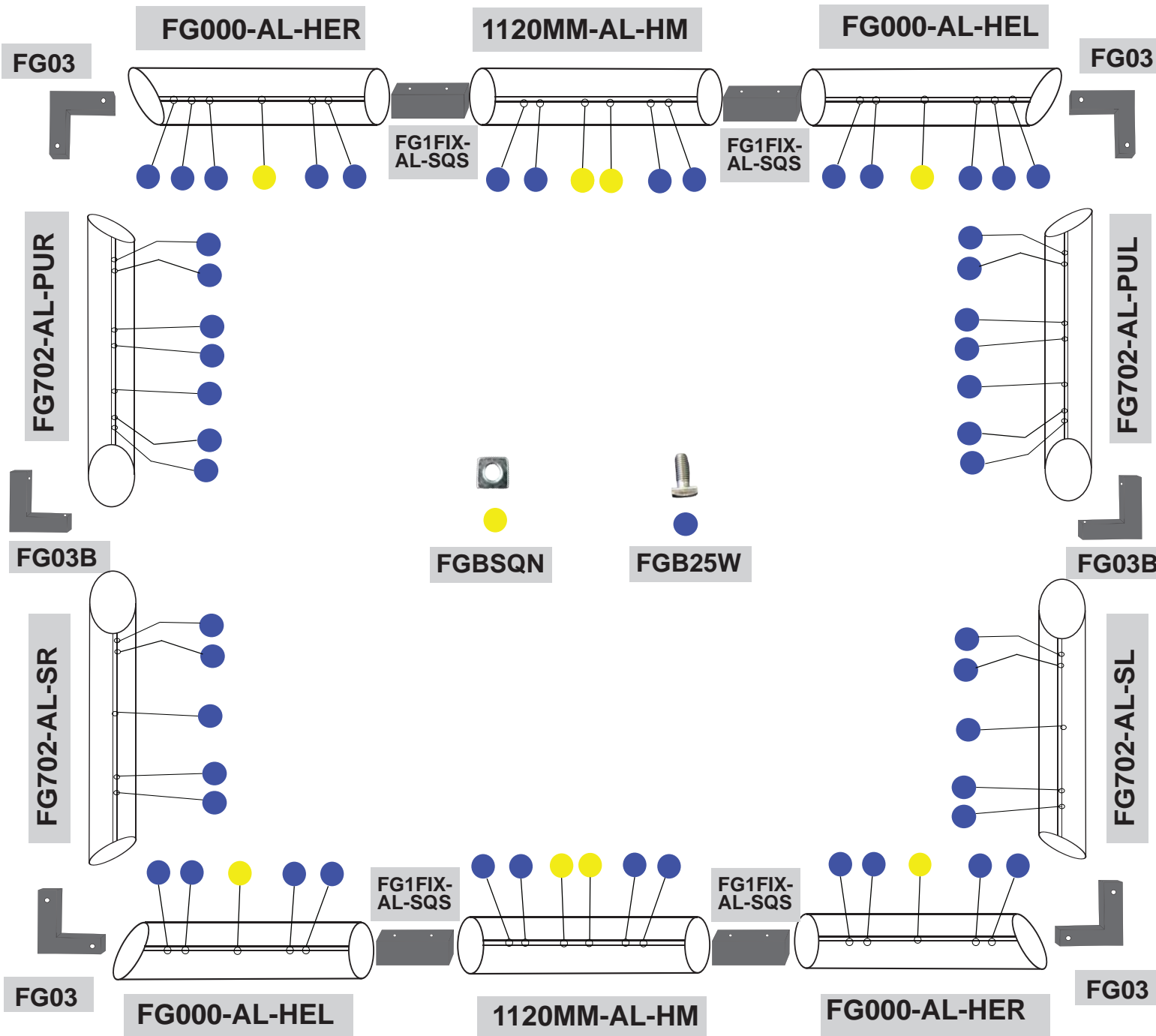
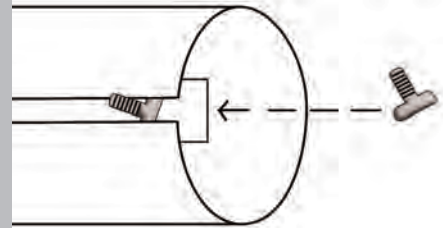

## ÉTAPE 2 : BARRES TRANSVERSALES

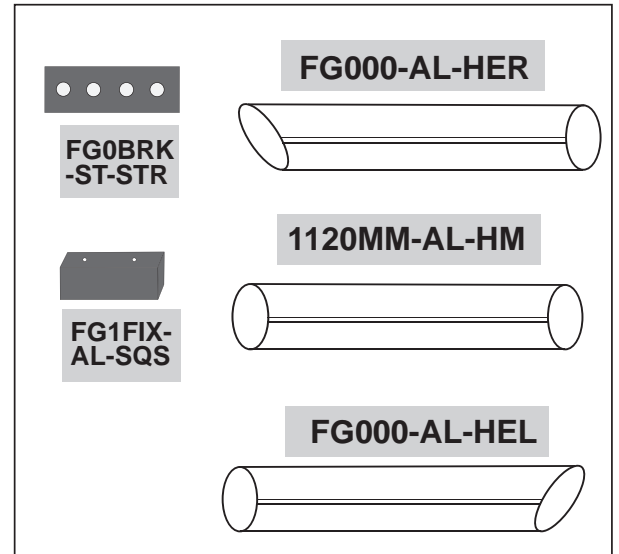
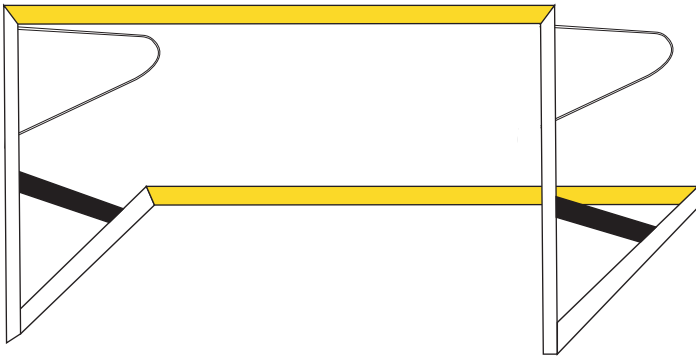

### 1/3 Emboiter les pièces - commencer par les côtés

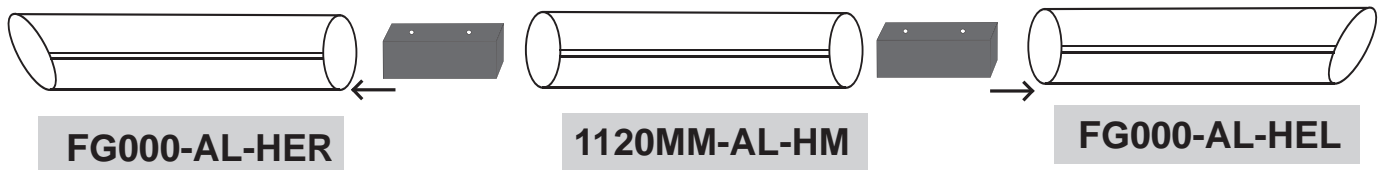

### 2/3 Fixer les deux vis

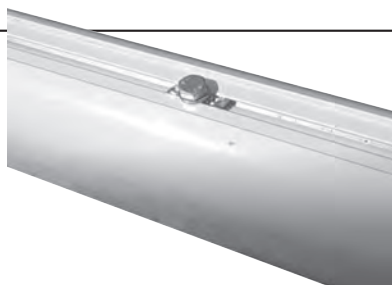
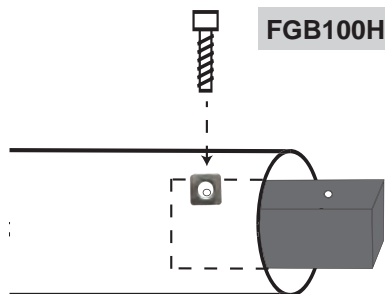

### 3/3 Fixer les boulons sur la platine

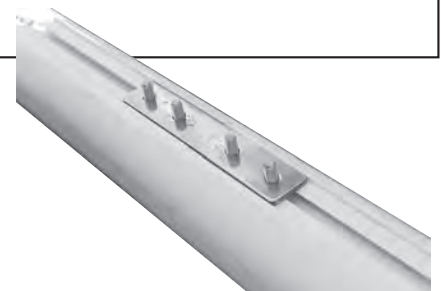
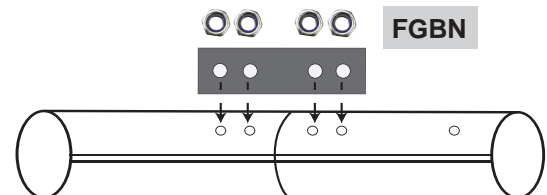

Répéter pour la barre arrière

# ÉTAPE 3 : ANGLES

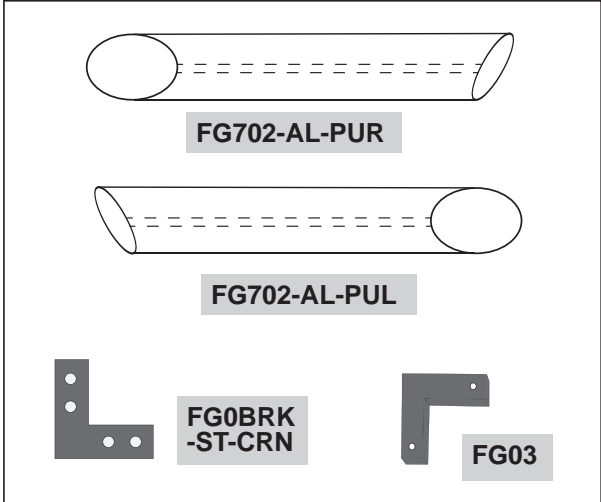
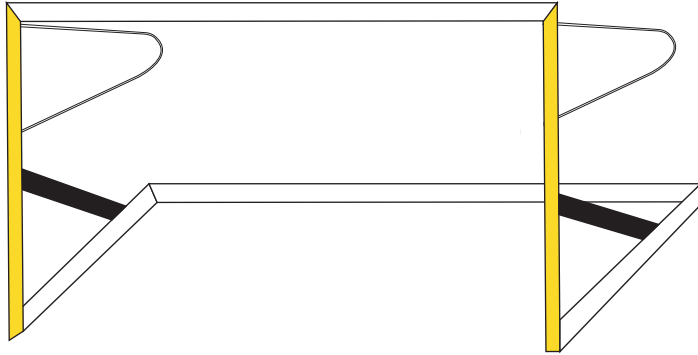

## 1/1 Emboiter les pièces

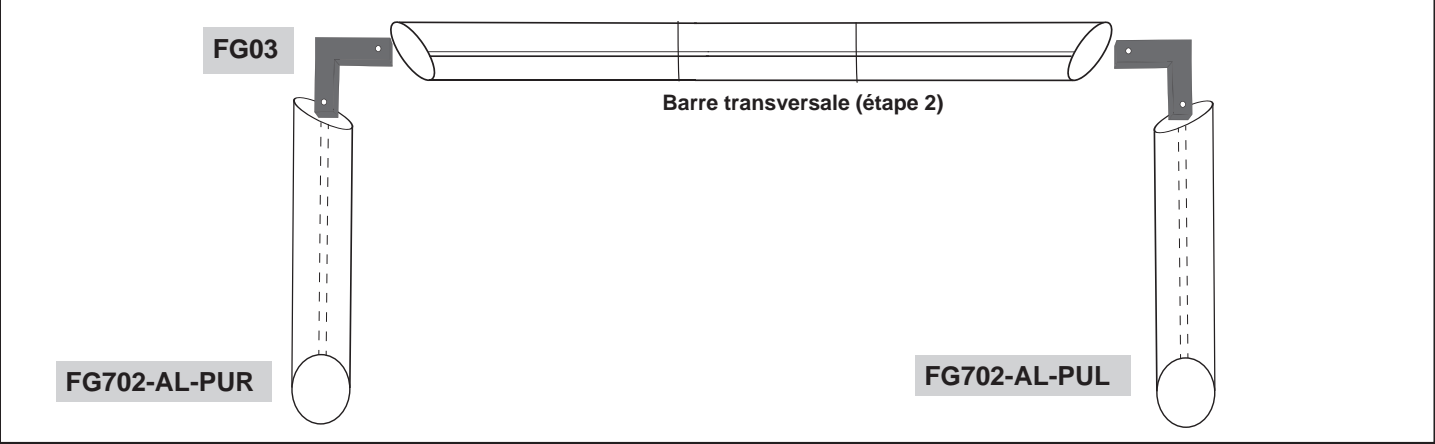

# ÉTAPE 4 : POTEAUX

## 1/1 Emboiter les pièces

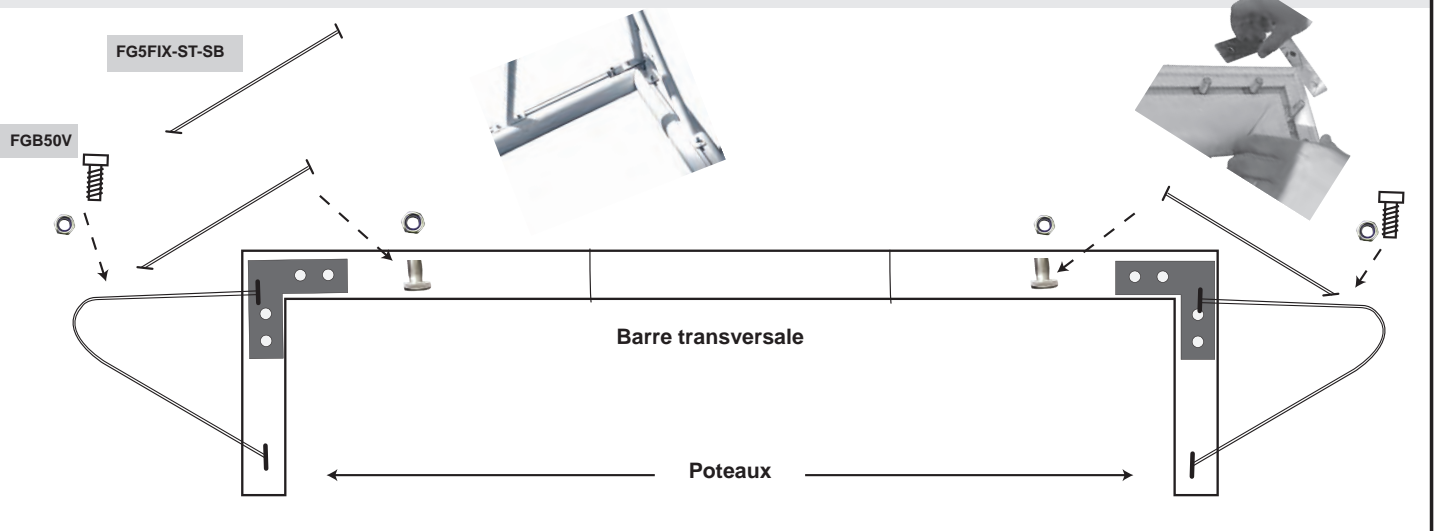

**ÉTAPE 5 : POTEaux ARRIÈRES et ASSEMBLAGE**

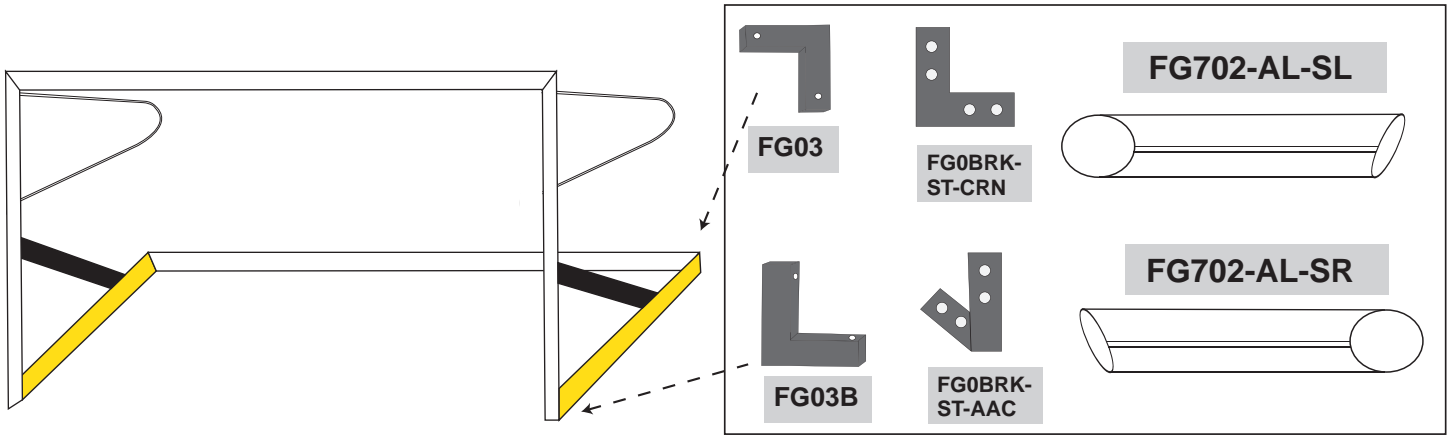

**1/3 Fixer les angles des poteaux arrière**

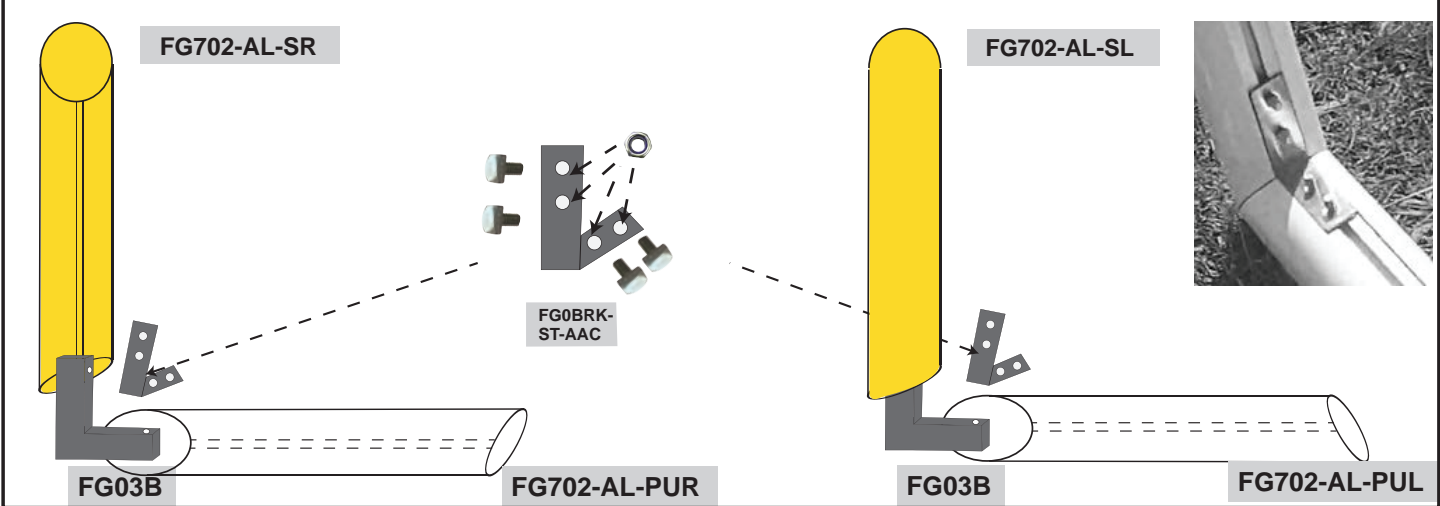

Il est fortement recommandé d'être au moins 3 personnes pour la suite du montage.

**2/3 Porter la barre arrière pour emboîter ses angles**

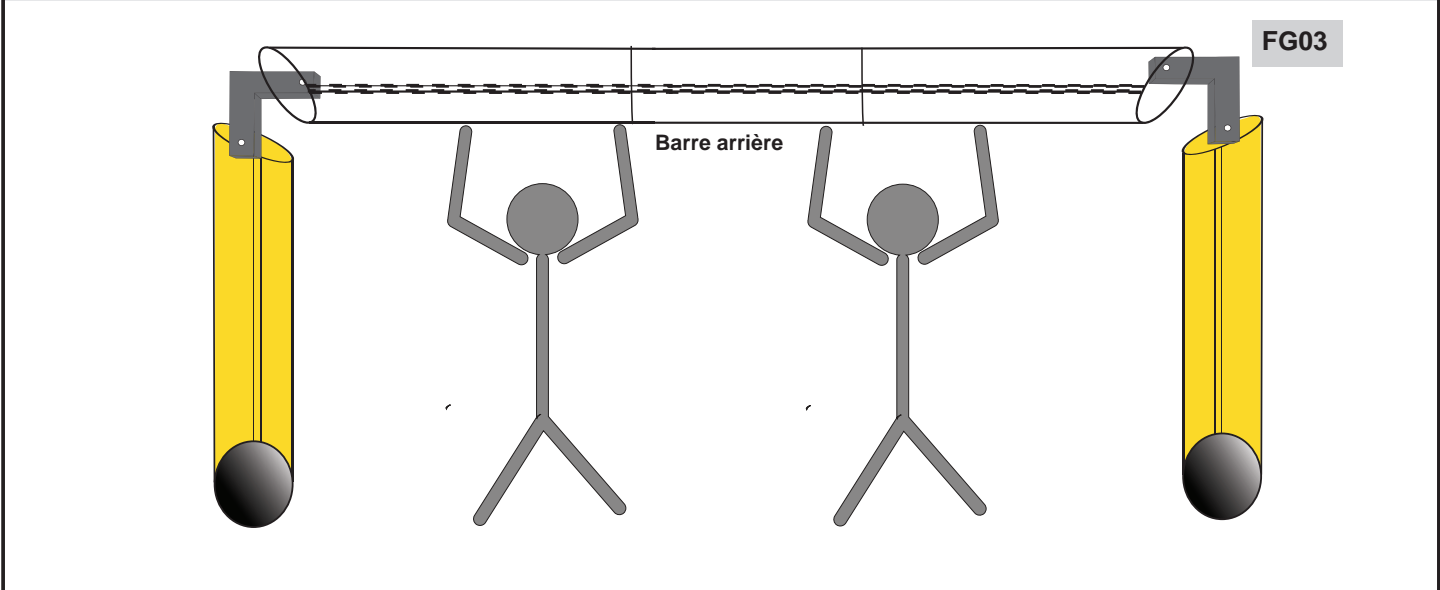

**3/3 Fixer les platines des angles**



**ÉTAPE 6 : BARRE DE RENFORT**

**1/1 Fixer le cadre arrière et les jambes de renfort puis verticaliser le but**

