

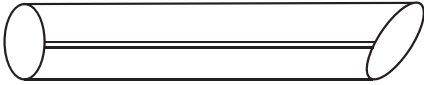

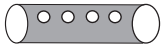

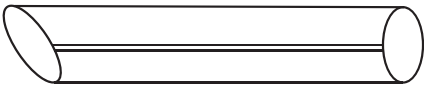
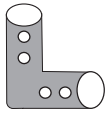
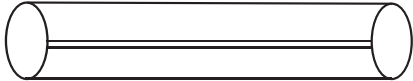
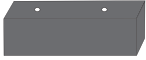
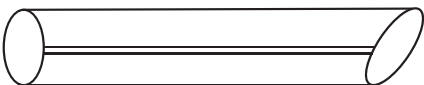
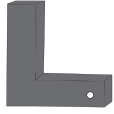
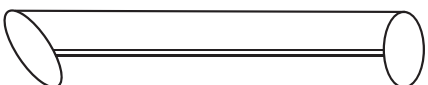
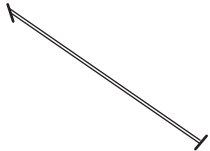

INVENTAIRE PIECES

| | | | |
|---|----------------------------|--|----------------------------|
|  | FG000-AL-HEL x1 |  | FG3FIX-ST-RDS x2 |
|  | FG000-AL-HER x1 |  | FG2FIX-ST-RDC x2 |
|  | 2440MM-AL-HM x1 |  | FG1FIX-AL-SQS x2 |
|  | FG1102-AL-PUR x1 |  | FG03 x2 |
|  | FG1102-AL-PUL x1 |  | FG4FIX-ST-LB x2 |
|  | 1750MM-ST-40D x2 |  | FG5FIX-ST-SB x2 |
|  | 2420MM-ST-40D x3 |  | FG4FIX-ST-NS x2 |
|  | FG01 x2 | | |

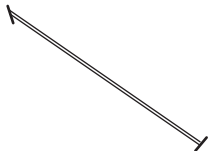
INVENTAIRE OUTILLAGE

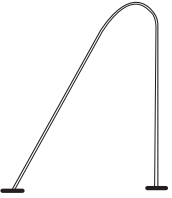
| | | | | | | | |
|--|----------------------------|---|----------------------|---|---------------------|---|----------------------------|
|  | FG0BRK-ST-STR x2 |  | FGB25W x30 |  | FGB50V x2 |  | FGB55V x16 |
|  | FG0BRK-ST-CRN x2 |  | FGB60V x2 |  | FGB70H x2 |  | FGBN x52 |
|  | FG0BRK-ST-SFC x2 |  | FGB100H x4 |  | FGBSQN X4 |  | FG02 clips filet |

Dans certains cas, vous pouvez recevoir 18 x FGB60V (au lieu des 55V) - la structure restera la même.

AVERTISSEMENTS

- L'installation de ce but doit se faire sans aucun marteau ou autre outil de force. Leur utilisation endommagera les pièces et annulera toute garantie sur le but.
- Les buts sont fournis avec des autollants comprenant les déclarations de normes de sécurité. Ces autocollants doivent à tout moment être fixés sur le but et visibles. Leur affichage fait partie des normes de sécurité et leur absence annule la garantie.
- En cas de difficulté ou problème avec le but, veuillez contacter le fabricant par mail avec des photos : Lynxsport GmbH - info@lynxsport.fr.

ÉTAPE 1 : VIS

! Poser toutes les pièces au sol suivant le schéma ci-dessous.

Avant d'emboîter les tubes, glisser toutes les vis dans les gouttières.

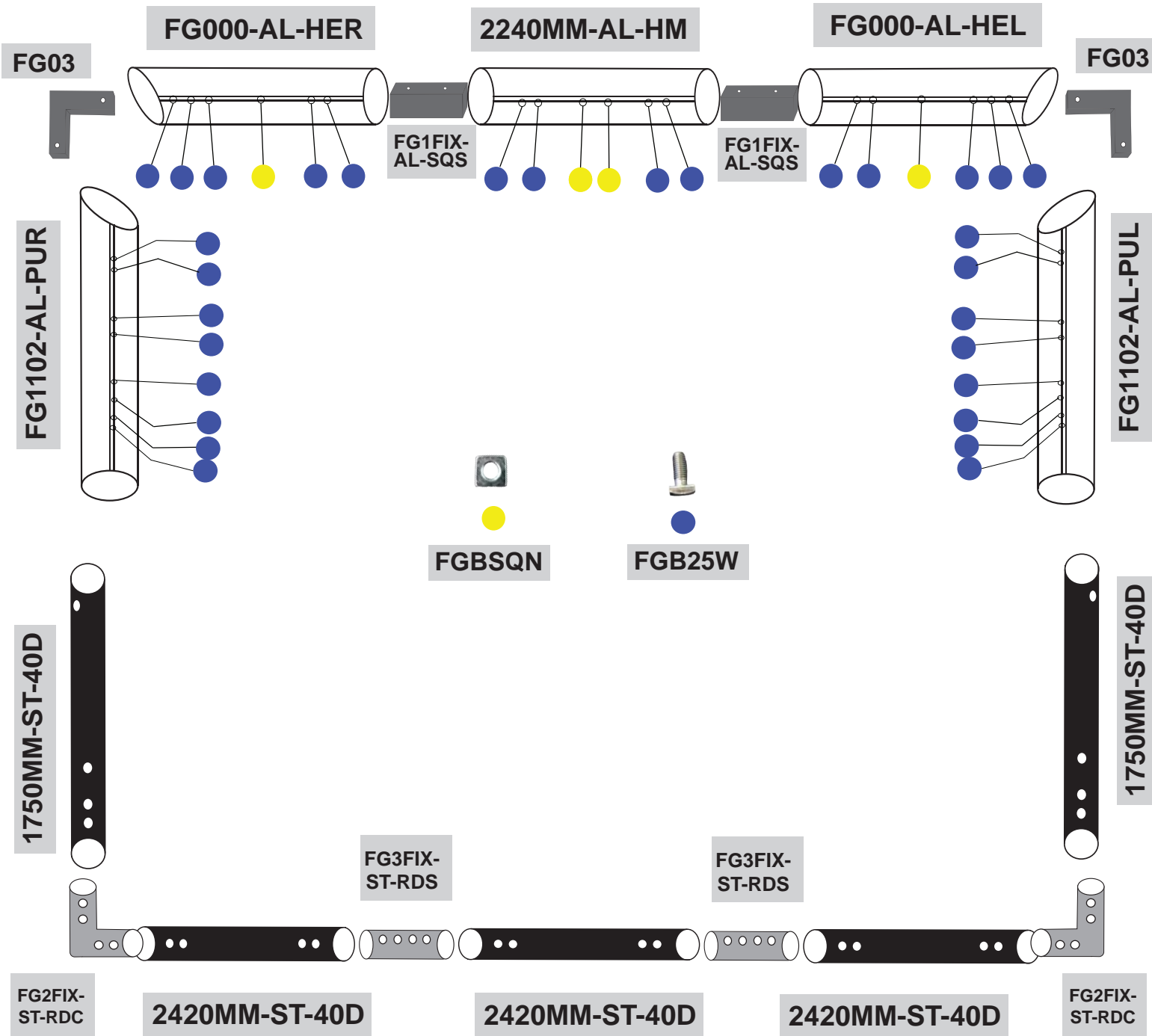
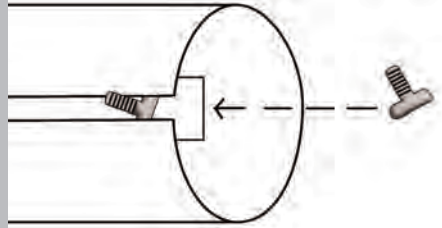

ÉTAPE 2 : BARRES TRANSVERSALES

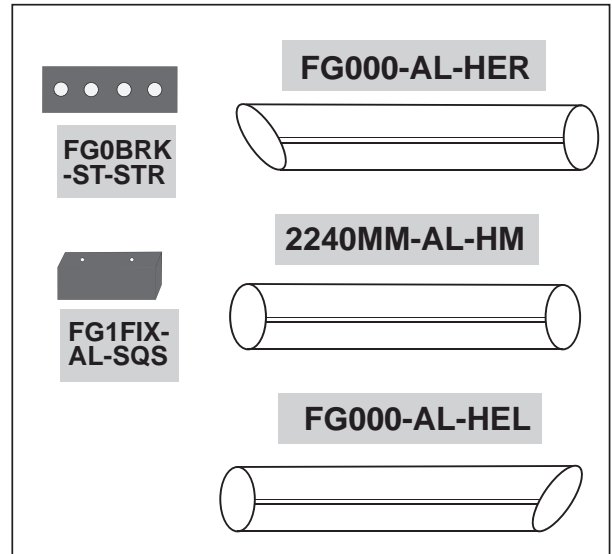
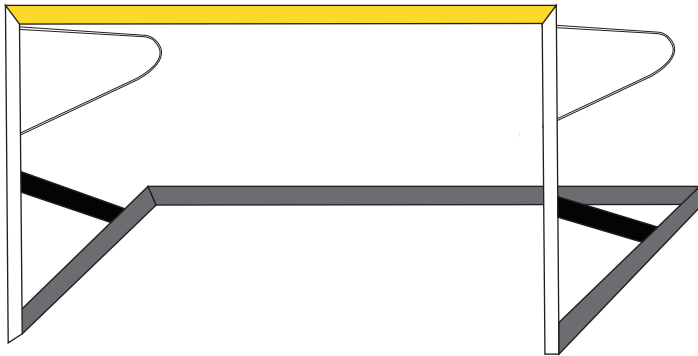

1/3 Emboiter les pièces - commencer par les côtés

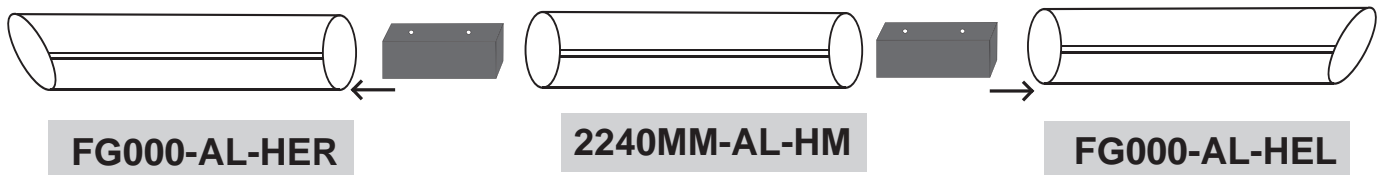

2/3 Fixer les deux vis

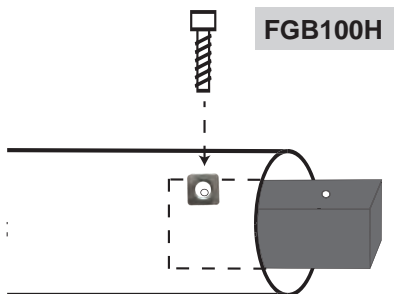

3/3 Fixer les boulons sur la platine

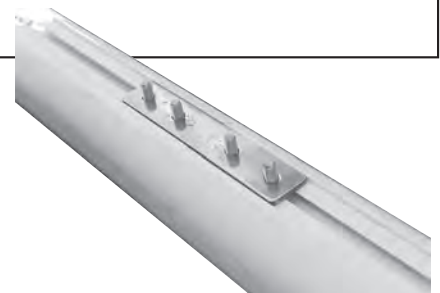
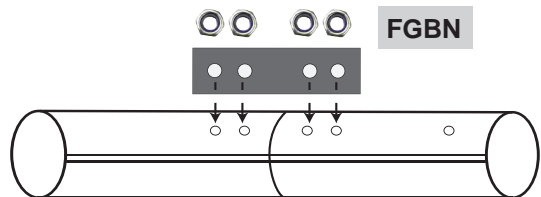

ÉTAPE 3 : ANGLES

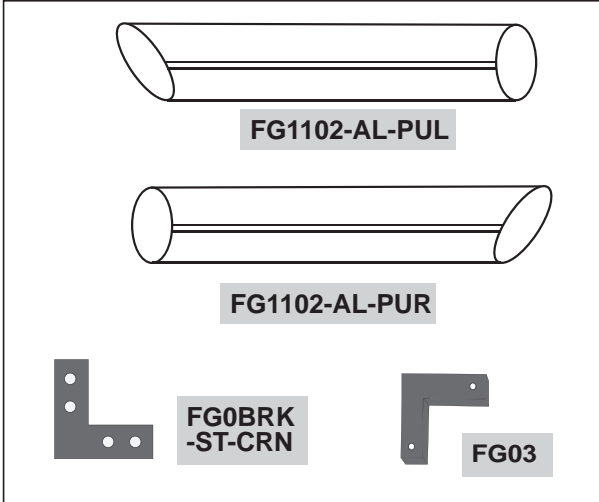
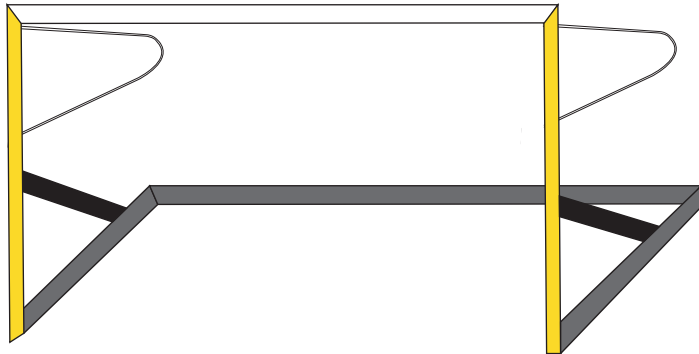

1/1 Emboiter les pièces

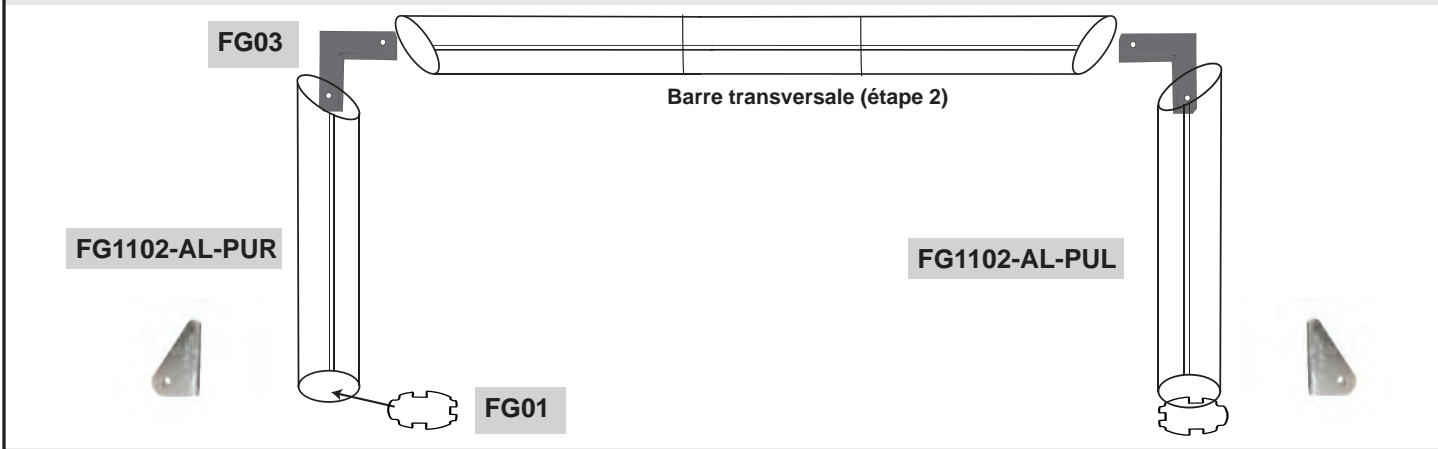

ÉTAPE 4 : POTEAUX

1/1 Emboiter les pièces

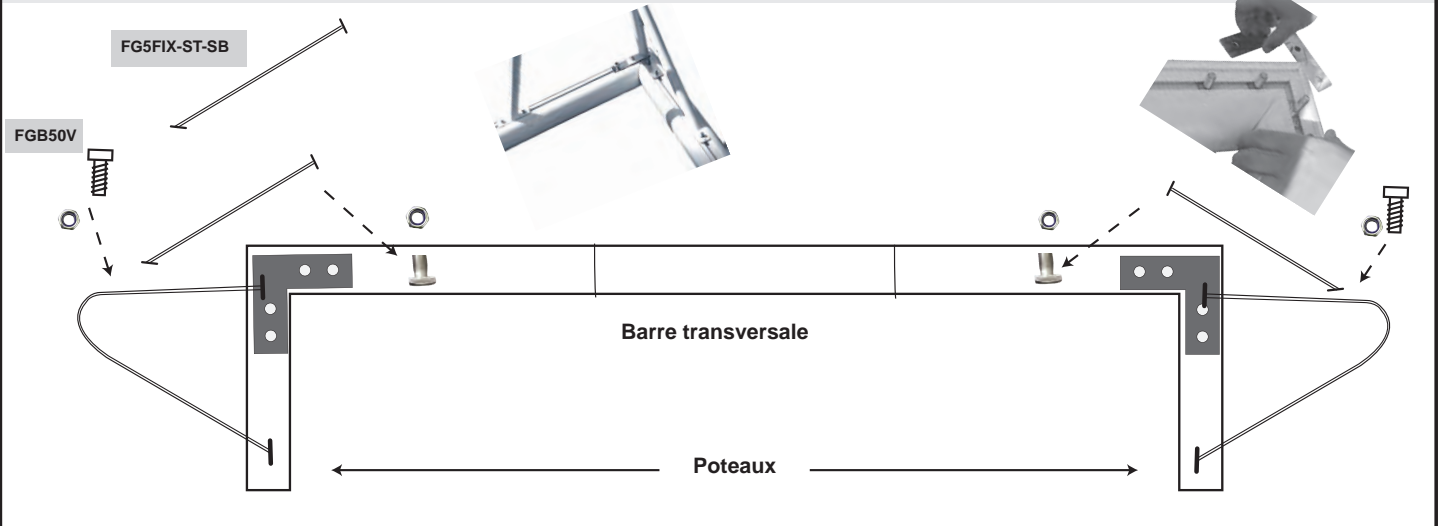

ÉTAPE 5 : CADRE ARRIÈRE

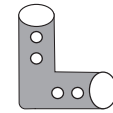
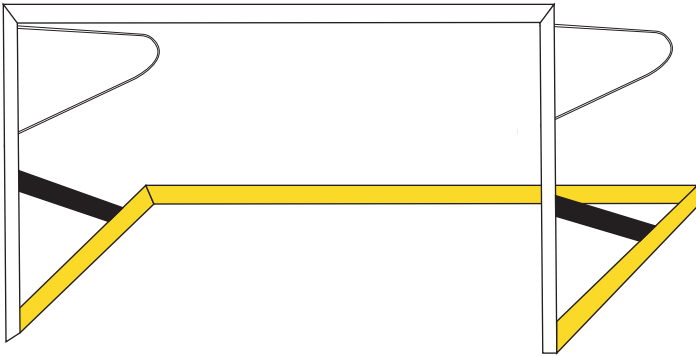

FG2FIX-ST-RDC



1750MM-ST-40D

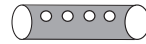

FG3FIX-ST-RDS



2420MM-ST-40D

1/1 Emboiter les pièces

Nous vous conseillons de mettre les visser par le bas, les boulons en haut

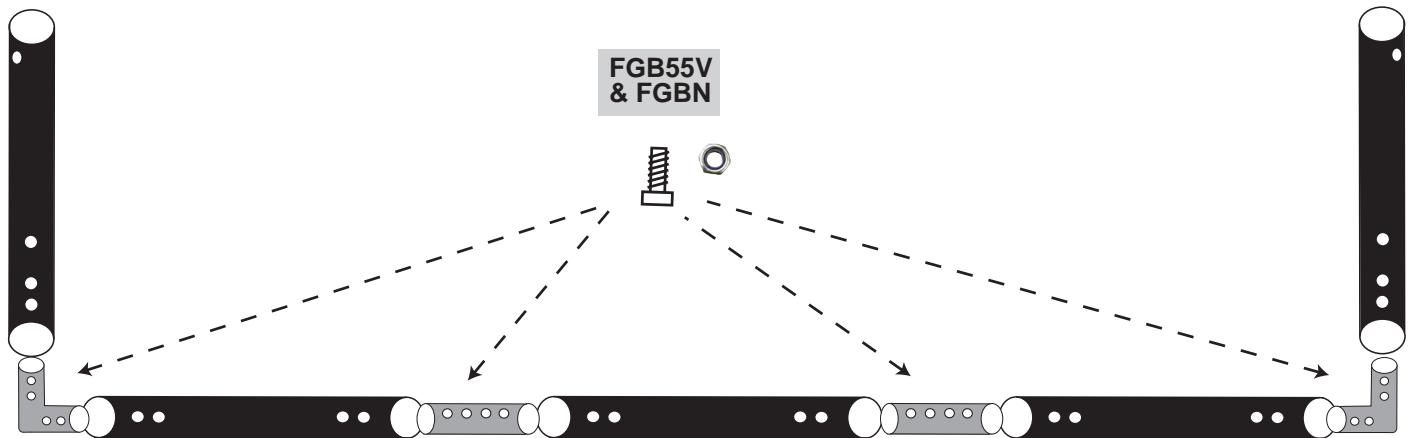

ÉTAPE 6 : BARRE DE RENFORT

1/1 Fixer le cadre arrière et les jambes de renfort, puis verticaliser le but

